



Easy-action
Door Closer

DORMA TS 83

Easy-action door closer with “thinking” backcheck

Easy to fix and even easier to adjust. The door closer for almost every door size and application.

Decades of experience have gone into the development of the DORMA TS 83.

The result is user comfort coupled with outstanding versatility. It can be adjusted to suit almost all types of door. It can even be supplied with additional

anti-corrosion protection for exposed applications or aggressive conditions. Fixing couldn't be easier – and last but not least – it's engineered for excellence.



Quality-assured manufacture to ISO 9001, EN 29001, BS 5750. Certified and verified by BSI Quality Assurance Reg.-No. Q 6423, FM 10756

Plus points

For the trade

- Low inventory costs and reduced stocking requirement thanks to streamlined product range.
- Practical and effective solutions to meet special applications thanks to comprehensive choice of accessories.

For the installer

- Easy to fix.
- Can be “tailored” to the requirements of the door by simple adjustment.
- Just one model for RH (DIN-R, ISO 5) and LH (DIN-L, ISO 6) doors, and for standard and frame/lintel fixing.
- Spring strength range EN 2–6 to suit virtually every application.

For the specifier/architect

- Compact closer design and sturdy flat-form arm assembly.
- Wide range of standard functions supplemented by optional extras.
- Suitable for fire doors.

For the user

- Optimum wall and door protection thanks to “thinking” backcheck.
- Closing speed virtually unaffected by temperature fluctuations.
- Proportionately low opening resistance thanks to high mechanical efficiency.



The TS 83 complies with the requirements and/or recommendations of the following:
BS 6459; PT1
CERTIFIRE approved for fire doors ITT; Ref. CF 118
PSA/MOB approved
DoH ref. (HTM 59)

Data and features

TS 83

Variable closing force	Spring strength	EN 2 – 6	EN 7
Standard doors ¹⁾	≤ 1400 mm ≤ 1600 mm	● –	– ●
External doors, outward opening ¹⁾	≤ 1400 mm ≤ 1600 mm	● –	– ●
To EN 1154, for fire doors ¹⁾	≤ 1400 mm ≤ 1600 mm	● –	– ●
Same model for RH (DIN-R, ISO 5) and LH (DIN-L, ISO 6)		●	●
Arm assembly type	Standard	●	●
	Flat-form	●	●
	Slide channel	–	–
Closing force variable by means of adjustment screw		●	–
Sweep speed variable by means of valve adjustment		●	●
Latching speed adjustable	at arm	●	●
	at valve	–	–
Backcheck	self-regulating	●	●
	adjustable at valve	●	●
Delayed action variable at valve		○	–
Hold-open		○	○
Weight in kg		3.3	3.3
Dimensions in mm	Length	293	293
	Overall depth	47.5	47.5
	Height	60	60

● yes – no ○ option

¹⁾ For applications involving particularly heavy or wide doors, and doors which have to close against wind resistance, the next highest closer size or a higher spring strength should be applied.

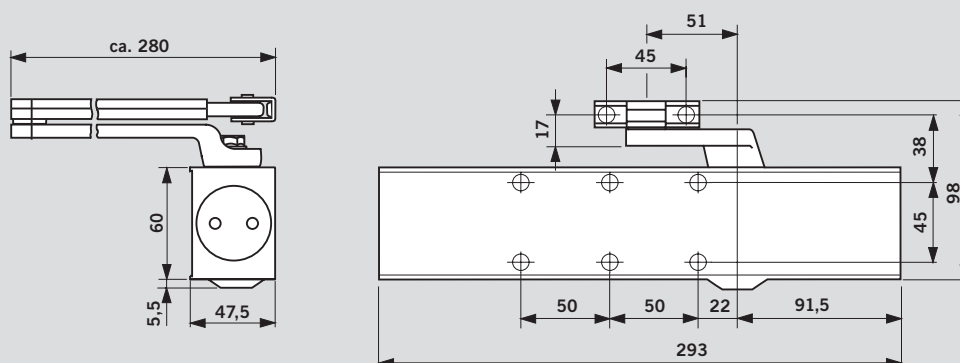

Door leaf fixing, pull side (example shows LH (ISO 6) door; RH (ISO 5) doors mirrored arrangement)

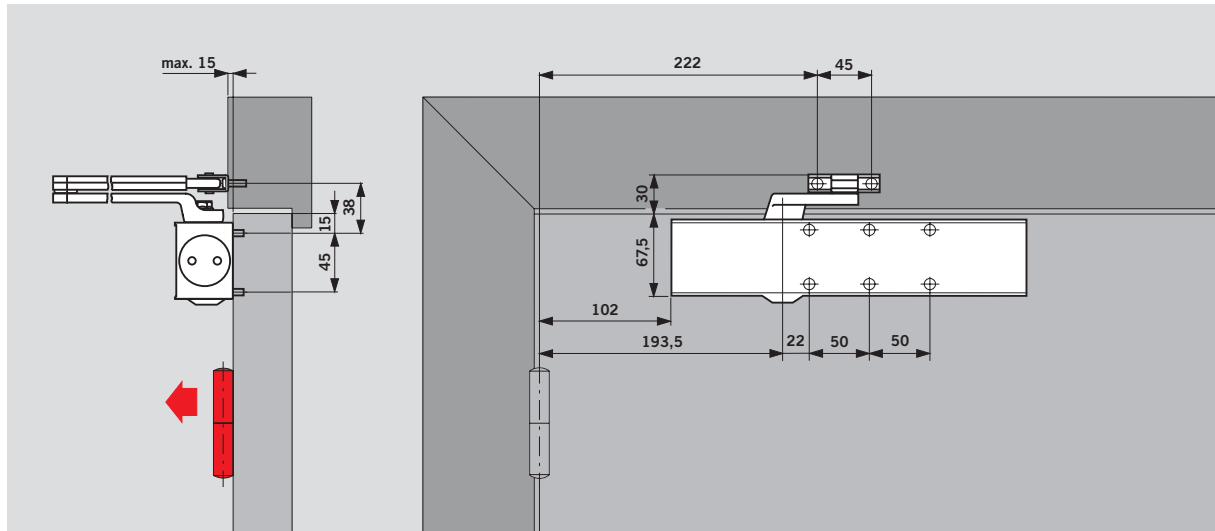

Transom fixing, push side (example shows LH (ISO 6) door; RH (ISO 5) doors mirrored arrangement)

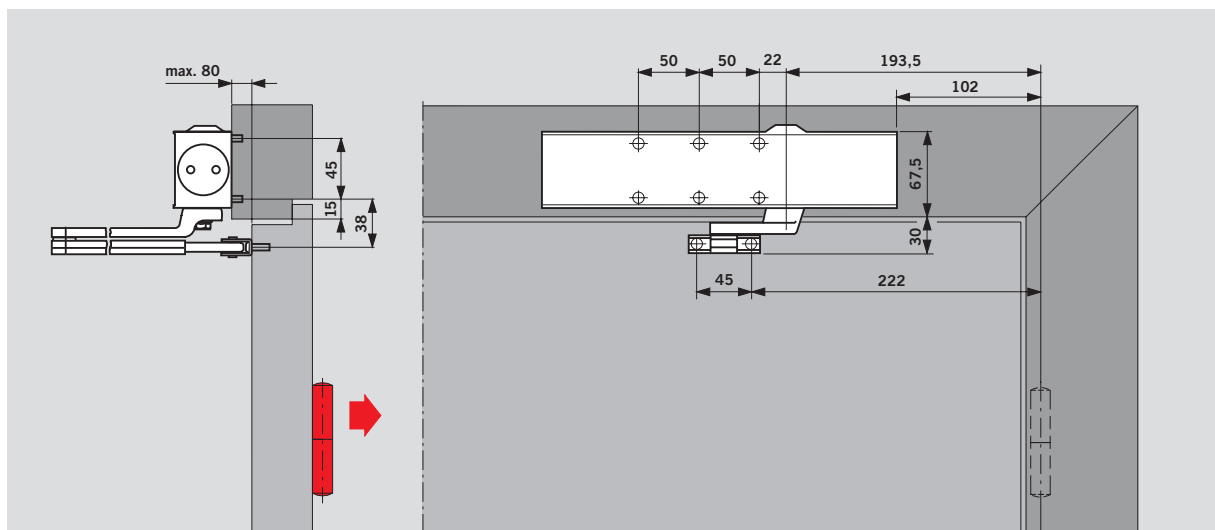

Transom fixing:

With transom-fixed closers, the backcheck only responds at between 85° and 90°, depending on the depth of reveal and type of door hinge involved; the delayed action, on the other hand, releases the door at an earlier point in its closing sweep.

In the case of fire doors, door closers may only be transom-fixed where appropriate approval has been obtained in the form of a certificate or test report issued by an accredited testing agency.

Mounting backplate

Art. No. 8380

For use with DIN fire doors and also as an intermediate plate when direct fixing to the door is not possible; with fixing hole pattern to EN 1154, supplement 1.

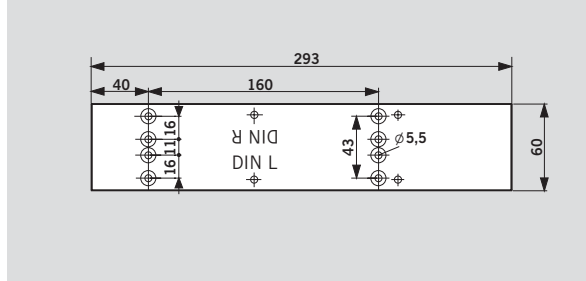
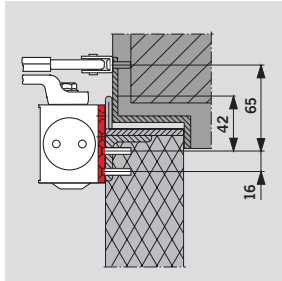

Arm bracket adapter plate

Art. No. 8365

For fixing the arm bracket to particularly narrow door frames.

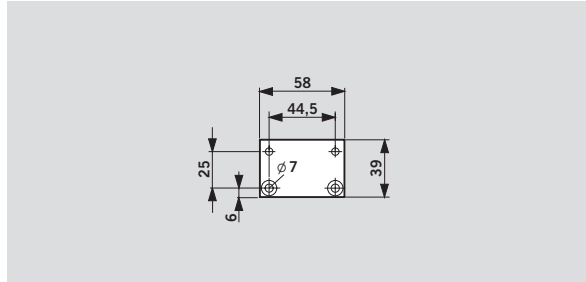
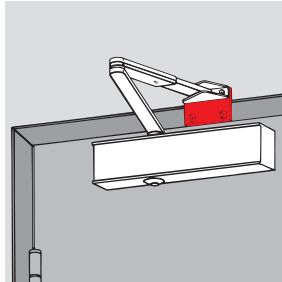

Angle bracket

Art. No. 8357

For frame/lintel fixing of the closer on the push side of doors with deep reveals.

Not approved for fire doors.

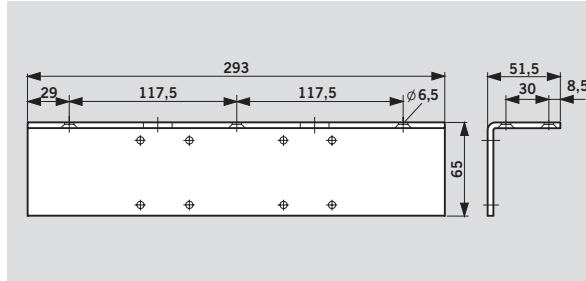
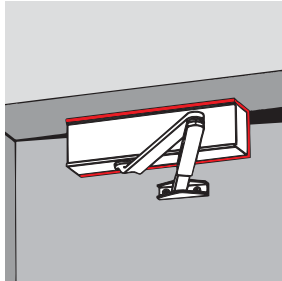

Drop plate

Art. No. 8359

For installation on frame when direct fixing of closer is not possible.

Not approved for fire doors.

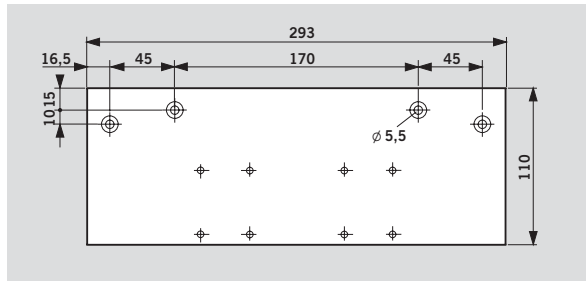
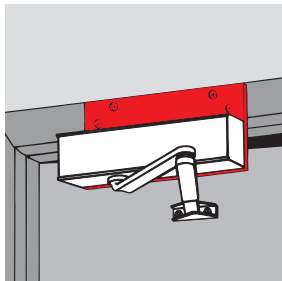

Parallel arm bracket

Art. No. 8382

For parallel arm installation on the push side (see fixing instructions for dimensions).

Not approved for fire doors.

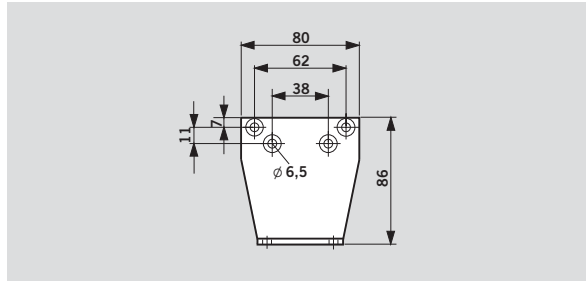
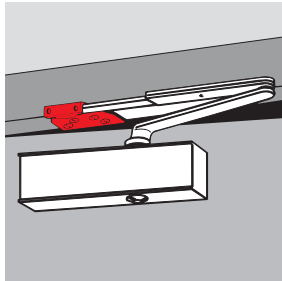

Spindle extension

Art. No. 8349

For increasing the distance between the closer and the arm assembly in the case of doors with a high overlap; 16 mm high.

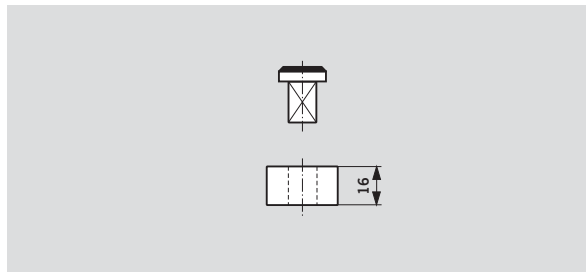
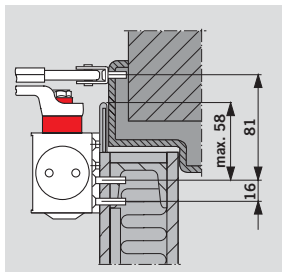

Standard and optional functions

With “thinking” backcheck – Model BC/ÖD

Thanks to an innovative design concept, the resistance developed by this backcheck system as the door is opened beyond approx. 70° is directly proportional to door acceleration. It is almost imperceptible when the door is opened slowly. However, if the door is opened hastily, the backcheck responds in equal measure.

And if the door should be flung open at speed – whether deliberately, thoughtlessly, accidentally or as a result of a gust of wind – the backcheck reacts at full strength, protecting the wall and door from damage.

If no backcheck function is required, the system can simply be switched off.

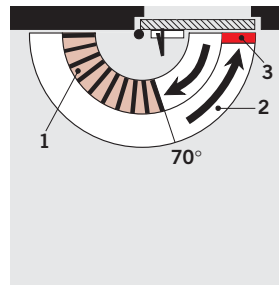

- 1 Self-regulating backcheck
- 2 Fully controlled closing with adjustable speed
- 3 Adjustable latch range

With additional delayed action – Model BC/ÖD + DC/SV

This model with its additional, integrated delayed action enables the closing cycle to be retarded within an adjustable range so that disabled persons, mothers with prams and people carrying bulky items are able to pass through the door without difficulty.

This model can also be used for fire doors.

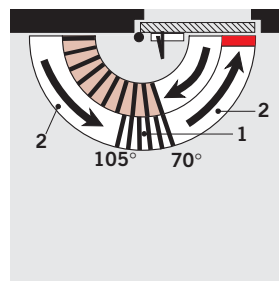
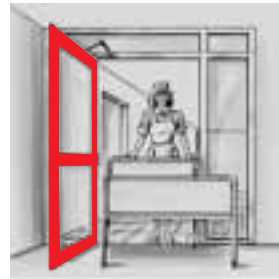

- 1 Adjustable delayed action
- 2 Fully controlled closing with adjustable speed

With hold-open – Model with hold-open arm





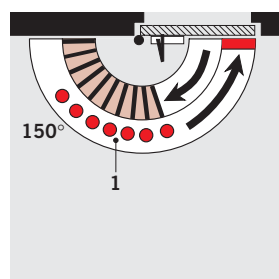

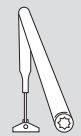
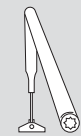

Combining the TS 83 with a hold-open arm enables the door to be held open at an appropriate angle (up to approx. 150°).

The hold-open function in the standard hold-open arm can be switched on and off by the user by simply pressing a switch.

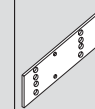

- 1 Hold-open range

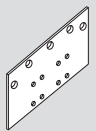
Hold-open arms are not approved for fire doors.

Supply and accessory information											
Closer body TS 83	Standard arm	Standard arm anti-corrosive type (AC)	Flat-form arm	Hold-open arm with on/off switch	Hold-open arm without switch	Mounting backplate	Arm bracket adapter plate	Angle bracket	Drop plate	Parallel arm bracket	Spindle extension 16 mm
											
	□ 280051xx		□ 830001xx	□ 830003xx	□ 830004xx	830011xx	830014xx	830013xx	830012xx	280066xx	830018xx
Size EN 2 – 6 BC/ÖD ■ 830101xx	□		□	□	□	#	#	#	#	#	#
Size EN 2 – 6 BC/ÖD (AC)		■ 830203xx				#	#	#	#	#	#
Size EN 7 BC/ÖD ■ 830501xx	□		□	□	□	#	#	#	#	#	#
Size EN 2 – 6 BC/ÖD+DC/SV ■ 830401xx	□		□	□	□	#	#	#	#	#	#

Order No.:

■ = Body only

□ = Arm only

■□ = Closer with arm, complete

= Optional accessory

Colour*):

silver

dark bronze

white (RAL 9016)

white (RAL 9010)

other

xx

01

03

11

10

09

*) Anti-corrosion protected closers and arms available in silver (01) only. Spindle extension in 01 and 03 only.

Specification text

Easy-action rack and pinion door closer with integral self-regulating backcheck; adjustable closing speed and adjustable latch range.

Model

- with additional, adjustable delayed action
- with standard arm
- with flatform arm
- anti-corrosion protected (AC)
- with hold-open arm
 - with without switch

Size

- EN 2 – 6, to EN 1154, spring strength adjustable
- EN 7 to EN 1154

Accessories

Colour

- silver
- dark bronze
- white (sim. RAL 9016)
- white (sim. RAL 9010)
- other (sim. RAL _____)

Model make DORMA TS 83

DORMA Door Controls Ltd.
DORMA Trading Park
Staffa Road
GB-London E10 7QX
Tel. 020 8558 8411
Fax 020 8558 6122
E-mail:
hardware@dorma-a-uk.co.uk

DORMA Door Controls Ltd.
19, Sandford Office Park
Foxrock
IRL-Dublin 18
Tel. 01 295 82 80-82
Fax 01 295 85 84
E-mail:
dormadublin@dorma.com

DORMA Door Controls Pte. Ltd.
No. 2, Jalan Terusan, Jurong
Singapore 619285
Rep. of Singapore
Tel. 0065 6268 7633
Fax 0065 6265 7914

DORMA Door Controls Pty. Ltd.
P.O. Box 1092
Narre Warren Vic 3805
52 Abbott Road
Hallam/Victoria 3803
Australia
Tel. 0061 3/97 96 35 55
Fax 0061 3/97 96 39 55

DORMA Gulf Door Controls FZE
Jebel Ali Free Zone, Roundabout 8,
Unit VC 02
P.O. Box 17268
Jebel Ali, Dubai
United Arab Emirates
Tel. 00971 48/83 90 14
Fax 00971 48/83 90 15

DORMA Door Controls (Pty.) Ltd.
Kings Court
P.O. Box 82182
2135 Southdale
South Africa
Tel. 0027 11/8 30 02 80
Fax 0027 11/8 30 02 91

DORMA GmbH + Co. KG
P.O. Box 40 09
D-58247 Ennepetal
Breckerfelder Straße 42-48
D-58256 Ennepetal
Germany
Tel. +49(0)23 33/7 93-0
Fax +49(0)23 33/79 34 95

The address of a subsidiary/representation in your area you can find at the DORMA website:
www.dorma.com